

VENTING - IT'S A SNAP TO USE

Simple Leak-Proof Gasketed Connections – No Sealant Required

Quick and Easy “Snap-Lock” Connections – No Clamps Required

High Quality – Category III Stainless Steel











Versatile – Vertical and Horizontal Terminations

Sliding Adjustable Pieces – No Need to Cut Pipes Out in the Field

Convenient – Vent Kits Available

UL Listed

Part Number	Description	
WALL THIMBLE		
9007855005	Wall Thimble 4.2"- 6.0" wall thickness	
9007856005	Wall Thimble 5.6"- 9.0" wall thickness	
9007608005	Wall Vent Terminator (Louver) 4.2"- 6.0" wall thickness	
9007741005	Wall Vent Terminator (Louver) 5.6"- 9.0" wall thickness	
9007609005	Wall Vent Terminator (Hood) 4.2"- 6.0" wall thickness	
9007742005	Wall Vent Terminator (Hood) 5.6"- 9.0" wall thickness	
9007680005	Concentric Termination 3.9"-7.1" Wall Thickness	
9007772005	Concentric Termination 6.9"-10.1" Wall Thickness	
9007773005	Concentric Termination 9.8"-13.0" Wall Thickness	
SUPPORT		
9007743005	Support Strap (2-inch)	
9007744005	Support Strap (4-inch)	
9007745005	Support Strap (8-inch)	
9007746005	Support Strap (12-inch)	
9007747005	Support Clamp	
STRAIGHT		
9007748005	6" Straight Vent Pipe	
9007749005	12" Straight Vent Pipe	
9007750005	24" Straight Vent Pipe	
9007751005	36" Straight Vent Pipe	
9007752005	48" Straight Vent Pipe	
ADJUSTABLE		
9007753005	8" Adjustable Vent Pipe	
9007754005	11" Adjustable Vent Pipe	
9007755005	17" Adjustable Vent Pipe	
9007756005	46" Adjustable Vent Pipe	

Part Number	Description	
ELBOW		
9007757005	45 Degree Elbow	
9007758005	90 Degree Elbow	
ADAPTOR		
9007759005	Female-Female Adaptor	
9007760005	Male-Female Adaptor	
BACKFLOW PREVENTION		
9007678005	4" Freeze Protection Vent Pipe	
9007679005	5" Freeze Protection Vent Pipe	
FIRESTOP		
9007761005	Vertical Firestop	
TERMINATION		
9007762005	Vent Termination Horizontal Louver	
9007763005	Vent Termination Horizontal Hood	
TERMINATION: RAIN CAP		
9007764005	Rain Cap	
Condensation Drain		
9007765005	Drain Tee (Horizontal)	

TANKLESS ACCESSORIES

Part Number	Description	
9007766005	Drain Tee (Vertical)	
ROOF FLASHING		
9007767005	Flat Roof Flashing	
9007768005	Angled Roof Flashing	
ROOF PIECES		
9007769005	Roof Jack	
9007770005	Storm Collar Pipe	
STORM COLLAR		
9007771005	Storm Collar	

CONCENTRIC DIRECT VENT TERMINATION KITS

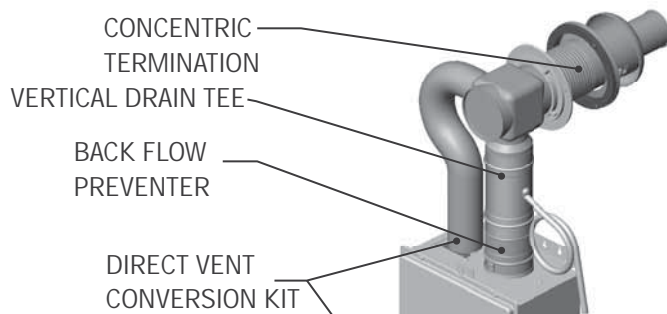

kit with remote:

- 9007846005 (Termination 4"-7")
- 9007847005 (Termination 7"-10")
- 9007848005 (Termination 10"-13")



kit without remote:

- 9007849005 (Termination 4"-7")
- 9007850005 (Termination 7"-10")
- 9007851005 (Termination 10"-13")

HORIZONTAL VENT KITS

9007774005		
Part #	Description	Qty
9007759005	Female-Female Adaptor	1
9007758005	Elbow 90 Degree	1
9007608005	Wall Vent Termination (Louver) 4.2" - 6.0" wall thickness	1

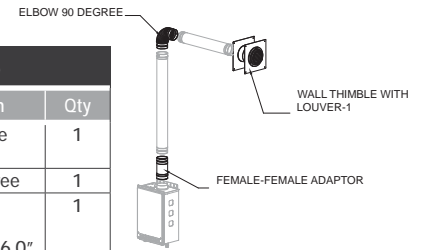

9007775005		
Part #	Description	Qty
9007766005	Drain Tee Vertical	1
9007758005	Elbow 90 Degree	1
9007608005	Wall Vent Termination (Louver) 4.2" - 6.0" wall thickness	1

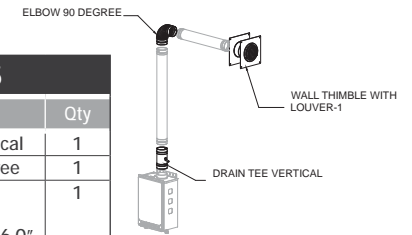

VERTICAL VENT KITS

9007776005		
Part #	Description	Qty
9007766005	Drain Tee Vertical	1
9007758005	Elbow 90 Degree	2
9007761005	Firestop	1
9007747005	Support Clamp	1
9007769005	Roof Jack	1
9007768005	Angle Roof Flashing	1
9007770005	Storm Collar Pipe	1
9007764005	Rain Cap	1

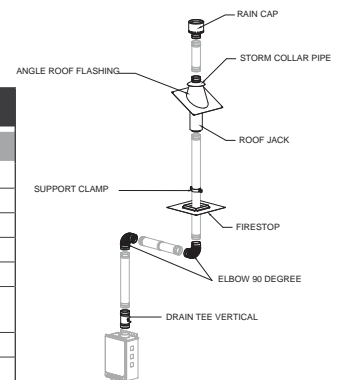

9007777005		
Part #	Description	Qty
9007766005	Drain Tee Vertical	1
9007757005	Elbow 45 Degree	2
9007761005	Firestop	1
9007747005	Support Clamp	1
9007769005	Roof Jack	1
9007767005	Flat Roof Flashing	1
9007770005	Storm Collar Pipe	1
9007764005	Rain Cap	1

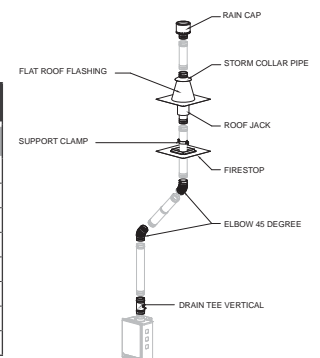

TANKLESS ACCESSORIES

CONCENTRIC DIRECT VENT KITS

Part Number	Description	110 INDOOR Non-Condensing		110 OUTDOOR Non-Condensing		310 INDOOR Non-Condensing		310 OUTDOOR Non-Condensing		510 INDOOR Non-Condensing		510 OUTDOOR Non-Condensing		520 INDOOR Condensing		520 OUTDOOR Condensing		710 INDOOR/OUTDOOR Non-Condensing		910 INDOOR/OUTDOOR STD/ASME Non-Condensing	
9007846005	Direct Vent Conversion Kit with Remote, Condensate Drain, Backflow preventer and Concentric Termination (4"-7")	X		X																	
9007847005	Direct Vent Conversion Kit with Remote, Condensate Drain, Backflow preventer and Concentric Termination (7"-10")	X		X																	
9007848005	Direct Vent Conversion Kit with Remote, Condensate Drain, Backflow preventer and Concentric Termination (10"-13")	X		X																	
9007849005	Direct Vent Conversion Kit with Condensate Drain, Backflow preventer and Concentric Termination (4"-7")	X		X				X													
9007850005	Direct Vent Conversion Kit with Condensate Drain, Backflow preventer and Concentric Termination (7"-10")	X		X				X													
9007851005	Direct Vent Conversion Kit with Condensate Drain, Backflow preventer and Concentric Termination (10"-13")	X		X				X													

ACCESSORIES

Part Number	Description	110 INDOOR Non-Condensing		110 OUTDOOR Non-Condensing		310 INDOOR Non-Condensing		310 OUTDOOR Non-Condensing		510 INDOOR Non-Condensing		510 OUTDOOR Non-Condensing		520 INDOOR Condensing		520 OUTDOOR Condensing		710 INDOOR/OUTDOOR Non-Condensing		910 INDOOR/OUTDOOR STD/ASME Non-Condensing		
9007666005	Remote Temperature Controller	X	X	X	X																	
9007603005								X	X	X	X	X	X	X	X	X	X	X	X	X	X	
9007667005	Direct Vent Conversion Kit	X		X				X														
9007668005																		X				
9007669005																					X	
9007670005					X	X	X	X														
9007671005		Pipe Cover	X	X																		
9007672005																			X			
9007673005																					X	
9007606005														X	X							
9007674005	Recess Box		X			X			X													
9007675005	Multiple Unit Controller																	X	X			
9007676005	Outdoor Vent Cap																	X				
9007677005																				X		
9007855005	Wall Thimble 4.2" - 6.0" wall thickness	X		X				X										X				
9007856005	Wall Thimble 5.6" - 9.0" wall thickness	X		X				X										X				
9007608005	Wall Vent Terminator (Louver) 4.2" - 6.0" wall thickness	X		X				X										X				
9007741005	Wall Vent Terminator (Louver) 5.6" - 9.0" wall thickness	X		X				X										X				
9007609005	Wall Vent Terminator (Hood) 4.2" - 6.0" wall thickness	X		X				X				X						X				
9007742005	Wall Vent Terminator (Hood) 5.6" - 9.0" wall thickness	X		X				X				X						X				
9007743005	Support Strap (2")	X		X				X										X				
9007744005	Support Strap (4")	X		X				X										X				
9007745005	Support Strap (8")	X		X				X										X				
9007746005	Support Strap (12")	X		X				X										X				
9007747005	Support Clamp	X		X				X										X				
9007748005	6" Straight Vent Pipe	X		X				X										X				
9007749005	12" Straight Vent Pipe	X		X				X										X				

TANKLESS ACCESSORIES

ACCESSORIES

Part Number	Description	110 INDOOR		110 OUTDOOR		310 INDOOR		310 OUTDOOR		510 INDOOR		510 OUTDOOR		710 INDOOR/OUTDOOR STD/ASME	
		Non-Condensing	Non-Condensing	Non-Condensing	Non-Condensing	Non-Condensing	Non-Condensing	Non-Condensing	Non-Condensing	Non-Condensing	Non-Condensing	Non-Condensing	Non-Condensing	Non-Condensing	Non-Condensing
9007750005	24" Straight Vent Pipe	X		X		X								X	
9007751005	36" Straight Vent Pipe	X		X		X								X	
9007752005	48" Straight Vent Pipe	X		X		X								X	
9007753005	6-8" Adjustable Vent Pipe	X		X		X								X	
9007754005	8-13" Adjustable Vent Pipe	X		X		X								X	
9007755005	13-22" Adjustable Vent Pipe	X		X		X								X	
9007756005	31-60" Adjustable Vent Pipe	X		X		X								X	
9007757005	45 Degree Elbow	X		X		X								X	
9007758005	90 Degree Elbow	X		X		X								X	
9007759005	Female-Female Adaptor	X		X		X								X	
9007760005	Male-Female Adaptor	X		X		X								X	
9007678005	4" Freeze Protection Vent Pipe	X		X		X				X				X	
9007679005	5" Freeze Protection Vent Pipe														X
9007761005	Vertical Firestop	X		X		X								X	
9007762005	Vent Termination - Horizontal Louver	X		X		X								X	
9007763005	Vent Termination - Horizontal Hood	X		X		X				X				X	
9007764005	Rain Cap	X		X		X				X				X	
9007765005	Drain Tee (Horizontal)	X		X		X				X				X	
9007766005	Drain Tee (Vertical)	X		X		X				X				X	
9007767005	Stainless Steel Flat Roof Flashing	X		X		X				X				X	
9007768005	Stainless Steel Angled Roof Flashing	X		X		X				X				X	
9007769005	Roof Jack	X		X		X				X				X	
9007770005	Storm Collar Pipe	X		X		X				X				X	
9007771005	Storm Collar	X		X		X				X				X	
9007680005	Concentric Termination 3.9"-7.1" Wall Thickness	X		X		X									
9007772005	Concentric Termination 6.9"-10.1" Wall Thickness	X		X		X									
9007773005	Concentric Termination 9.8"-13.0" Wall Thickness	X		X		X									
9007774005	Horizontal Vent Kit	X		X		X								X	
9007775005	Horizontal Vent Kit (with drain tee)	X		X		X								X	
9007776005	Vertical Vent Kit (angled roof)	X		X		X								X	
9007777005	Vertical Vent Kit (flat roof)	X		X		X								X	
9007604005	Isolation Valve Kit (lead free)	X	X	X	X	X	X	X	X	X	X	X			
9007605005	Isolation Valve Kit	X	X	X	X	X	X	X	X	X	X	X			
9007778005	Isolation Valve Kit (lead free)													X	
9007779005	Isolation Valve Kit													X	
9007780005	Isolation Valve Kit (lead free)														X
9007781005	Isolation Valve Kit														X
9007610005	PVC Intake Adaptor									X					
9007611005	PVC Concentric Termination									X					
9007607005	Neutralizer Kit									X	X				

Technical Support • phone: 877-737-2840